

# LIGHTPOLE INTERNATIONAL

Telephone: 780-719-9918

E-Mail: lightpoledirector@hotmail.com

Two Piece Light Pole CSA# BS23FTS

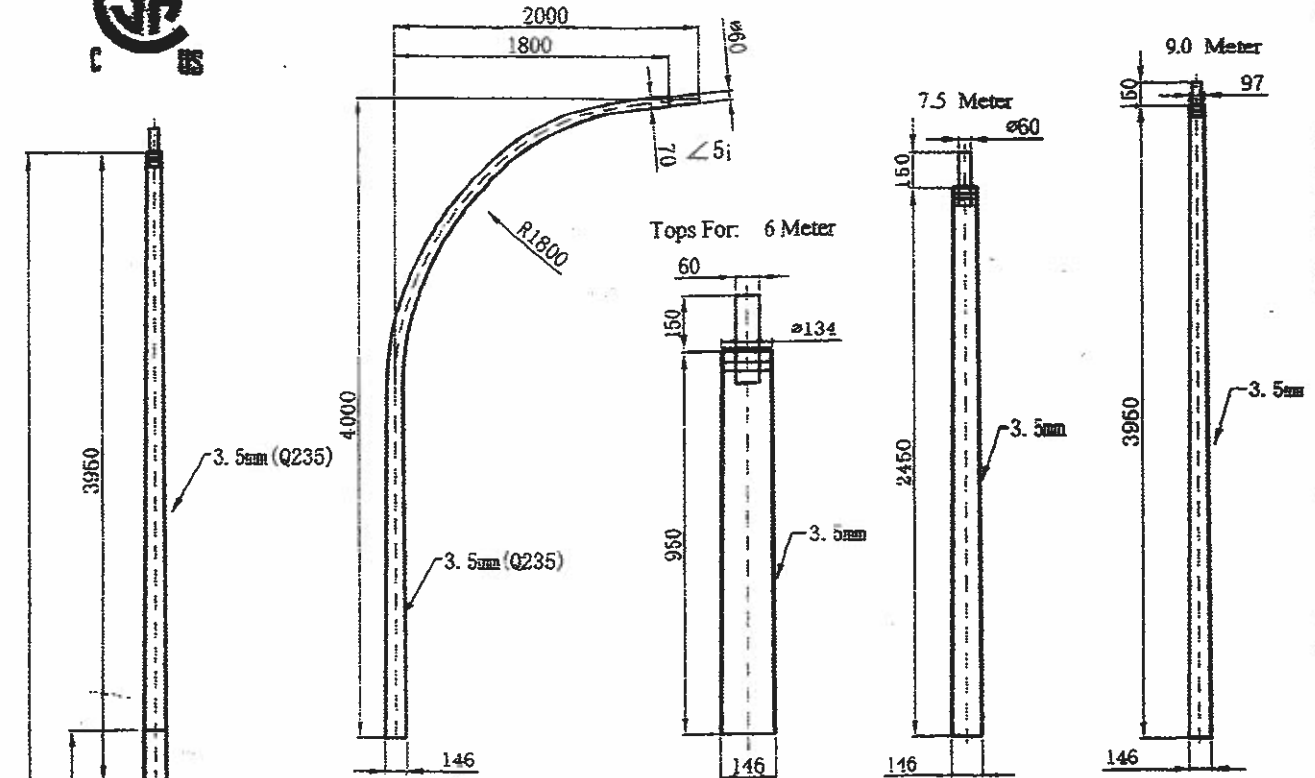

The overlap

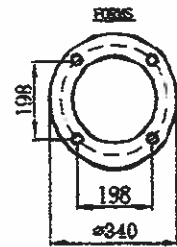
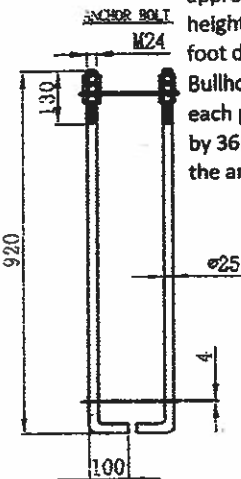
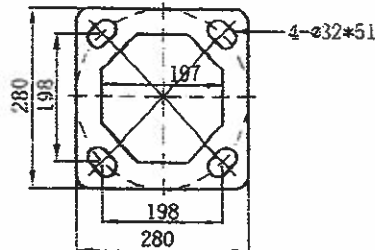
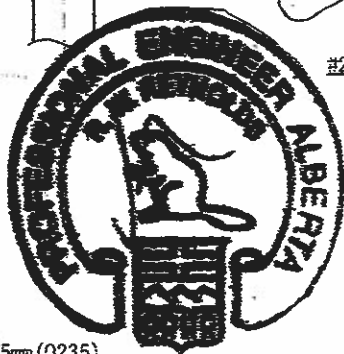
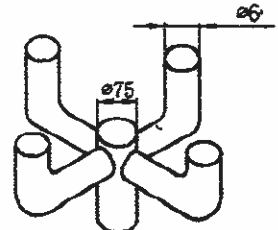
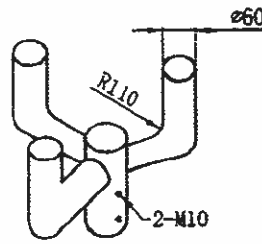
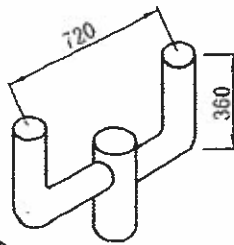
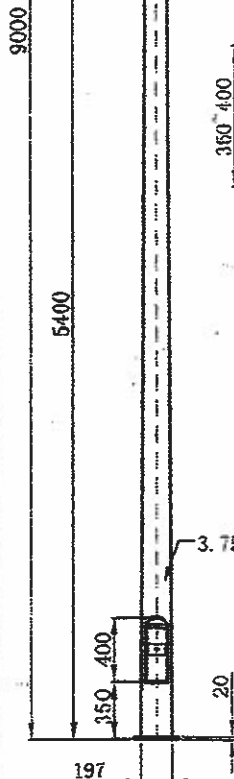

These specifications are for our straight galvanized octagon CSA approved poles in 20, 25 or 30 feet height. Also a 30 foot pole with 6 foot davit.

Bullhorns permit 2, 3 or 4 lamps on each pole and anchor bolts are 1 inch by 36 inches long. The forms secure the anchor bolts when put into concrete